

Bastelbogen für Einsatzboot der Kategorie 2



Bauanleitung:

Erster Schritt:

Ausschneiden der einzelnen Teile der ersten Baugruppe; Klebekanten knicken

Zweiter Schritt:

Die Klebekanten mit Kleber bestreichen und die Klebekante ansetzen;

Dritter Schritt:

Einzelteile der Baugruppe zusammenfügen;

Vierter Schritt:

Wiederholen der Schritte eins bis drei für die nächste Baugruppe;

Bei den  gekennzeichnete Bauteile bitte nach dem Ausschneiden das Papier aufrollen.

Die hintere Fläche zu Verdoppeln nehmen

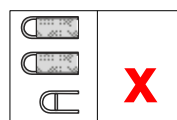

Empfohlene Papierstärke: 120-160 g/m²



Bootsrumpf / äussere und innere Schale

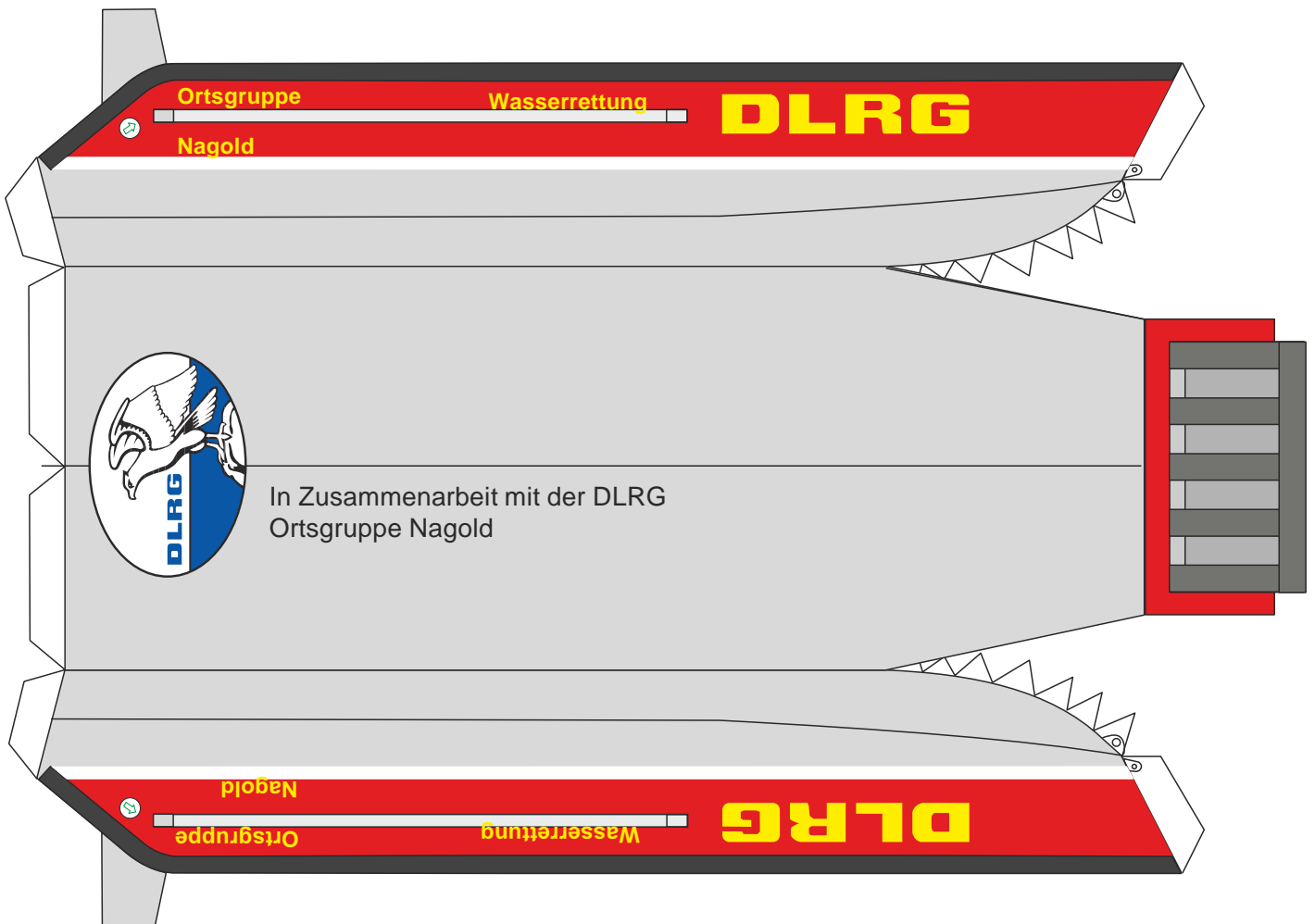
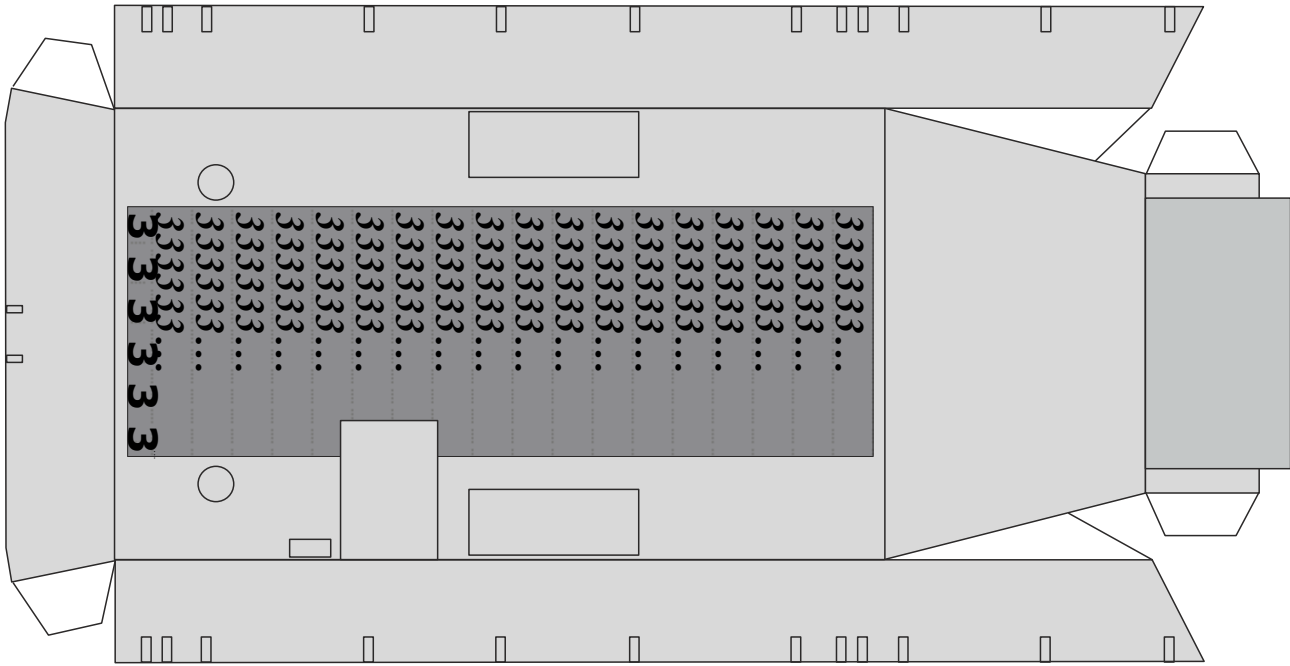

Bootsheck / Motorspiegel

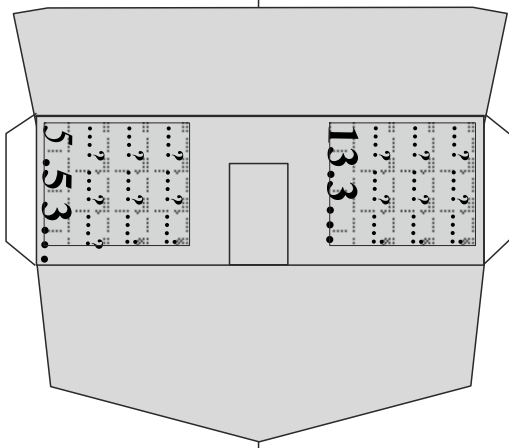

Bootsführer und Bootsgast-Sitz

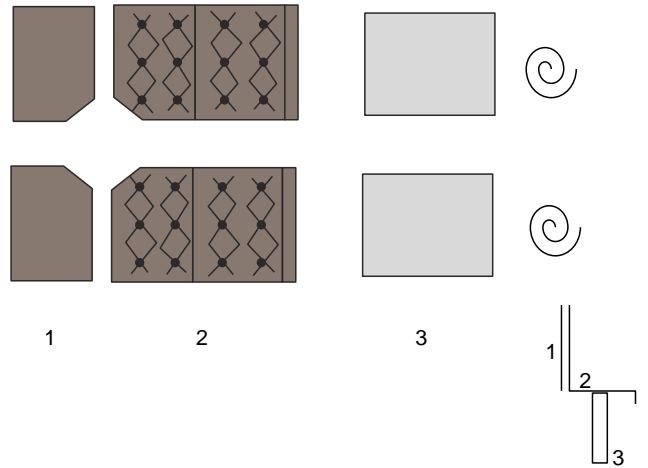

Stau- und Sitzkisten, 2 Stück

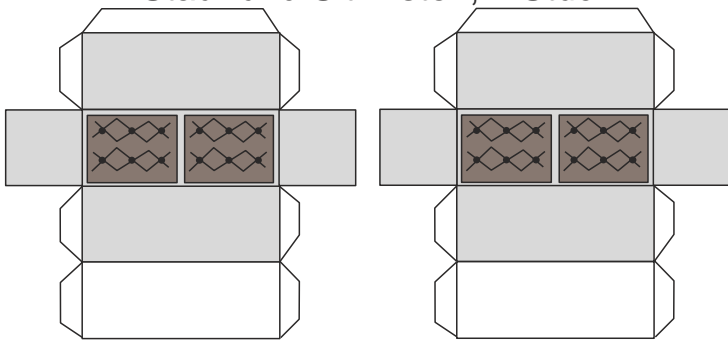

Bugklappe Aussenwand

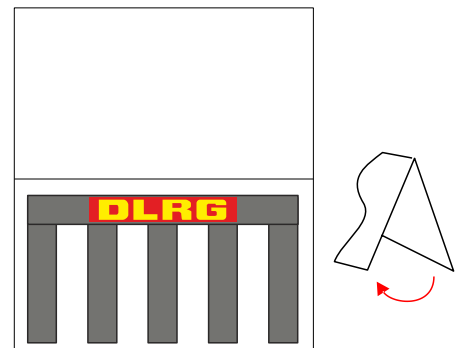

Bauteile für Steuerstand

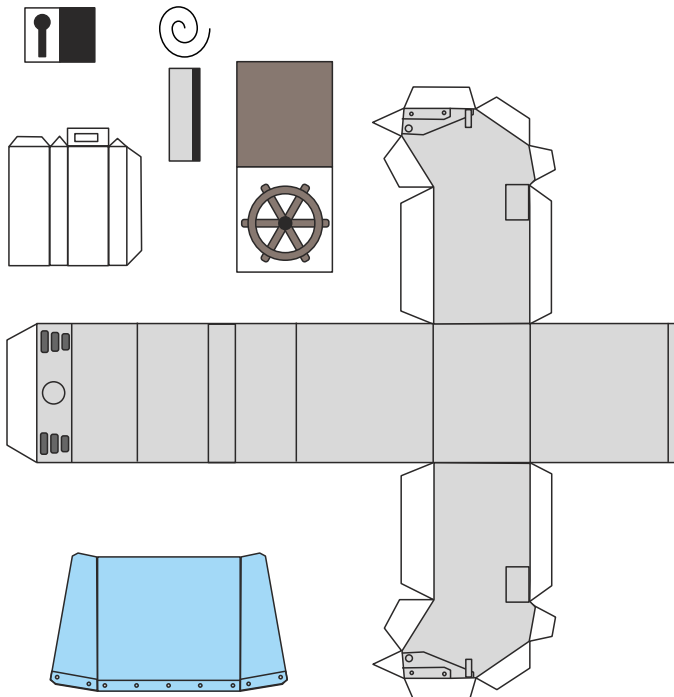

Bauteile für Motor

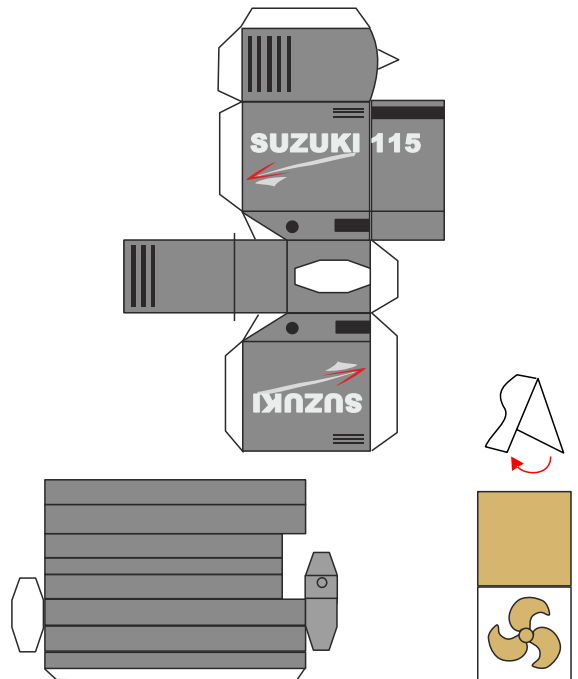

Bügelaufbau

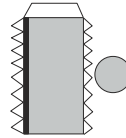
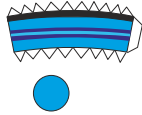
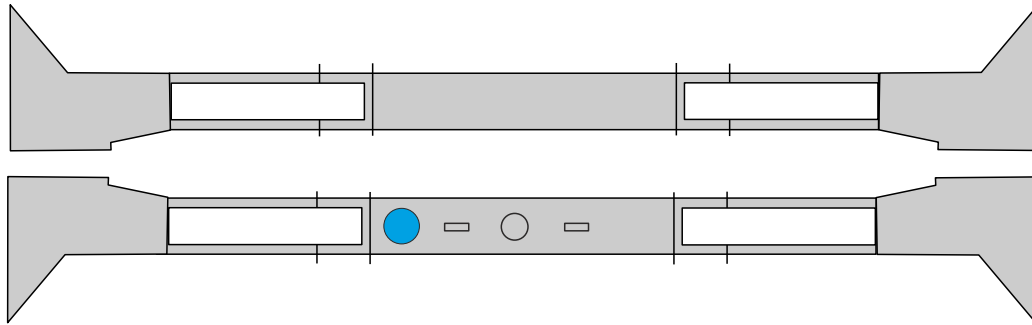

Backbord-und Steuerbord-Reling

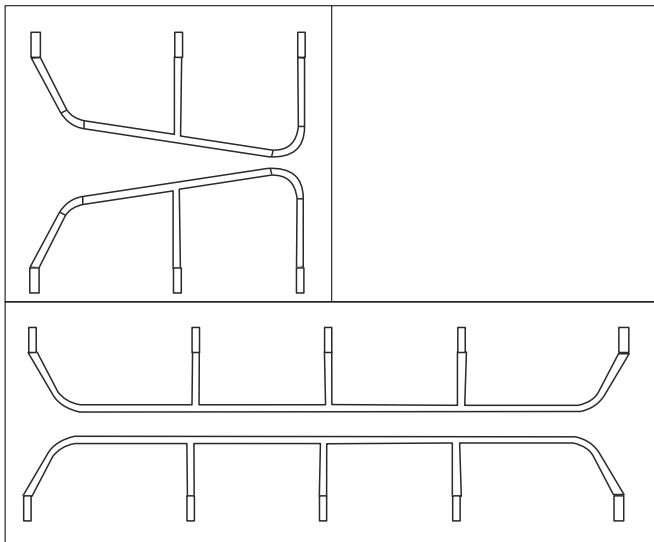

Belegklampen

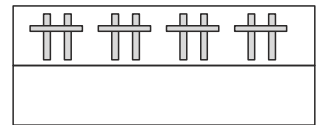
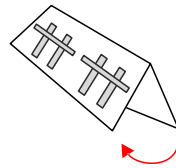

Streifen-Aussbordwand

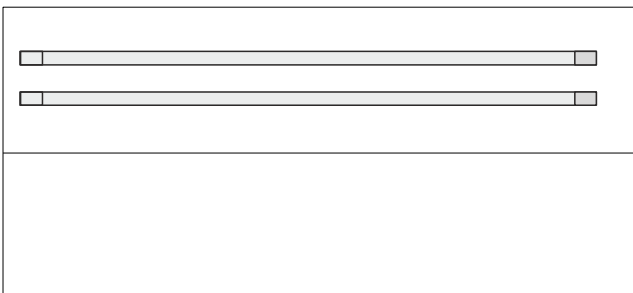

Trittbleche Bootsheck

